



Hi-Rel COTS

Ruggedised COTS AC/DC Power Supply

Ultra-high efficiency 1U size



PLUG & PLAY POWER next generation power source

FEATURES

- MIL-STD-810G: Shock & Vibration
- MIL-STD-461F: EMC
- Conformal Coated & Ruggedised as standard
- Operating temperature range of -55 to 70 °C
- 47-440Hz input frequency
- Anti-Vibration Compound
- 1V to 53V standard output voltages
- All outputs fully floating
- Extra low profile: 1U height (40mm)
- Ultra high efficiency, up to 91%
- Plug & Play Power
 - allows fast custom configuration
 - Outputs completely field configurable with option to factory fix
- Series / Parallel outputs for higher voltages and currents
- Parallel powerpacs for higher power
- OVP, OTP, OCP as standard
- 5V/250mA bias standby voltage provided
- Individual output control
- 3 Year Warranty

APPLICATIONS INCLUDE

- Harsh Industrial Electronics
- Radar (Naval, Ground Based)
- Communications
- Test & Measurement

The XF family of power supplies provides up to an incredible 1000W in an extremely compact 1U x 268 x 127mm package. Employing an innovative plug & play architecture the XF family brings unprecedented flexibility that allows users to instantly configure a custom power solution in less than 5 minutes.

Designed for use in harsh operating environments, the XF family is conformal coated and ruggedised to withstand extremes in shock and vibration as well as operation over a wide temperature range of -55 to 70°C. Applications include Harsh Industrial, Test and Measurement, Communications, Fixed and Mobile Radar and Military Electronics which require COTS solutions.

All configurations carry full safety agency approvals, including UL60950 and EN60950 and are fully characterised for EMC according to MIL-STD-461F. All configurations meet the MIL-STD-810G standard for shock and vibration. EMC characterisation, Shock and Vibration and Thermal Stress reports are available.

For further details please contact support@excelsys.com.

powerMods

MODEL	Vtrim	Vmin	Vnom	Vmax	I _{max}	Watts
Xg1C	1.0	1.5	2.5	3.6	50A	125W
Xg2C	1.5	3.2	5.0	6.0	40A	200W
Xg3C	4.0	6.0	12.0	15.0	20A	240W
Xg4C	8.0	12.0	24.0	28.0	10A	240W
Xg5C	8.0	24.0	48.0	53.0	6A	288W
Xg7C	5.0	5.0	24.0	28.0	5A	120W
Xg8Cv ₁	5.0	5.0	24.0	28.0	2.5A	60W
v ₂	5.0	5.0	24.0	28.0	2.5A	60W

powerPacs

Hi-Rel COTS	Model	Power
Hi-Rel COTS	XFA	400W
	XFB	700W
	XFC	1000W

Conformal Coated *powerMods*, Xg1C to Xg8C, MUST be used with XF *powerpacs*.

EFFICIENCY (typical)

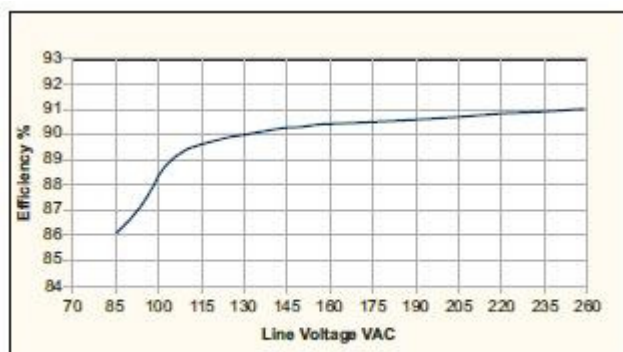

MECHANICAL SPECIFICATIONS

XFA, XFB, XFC

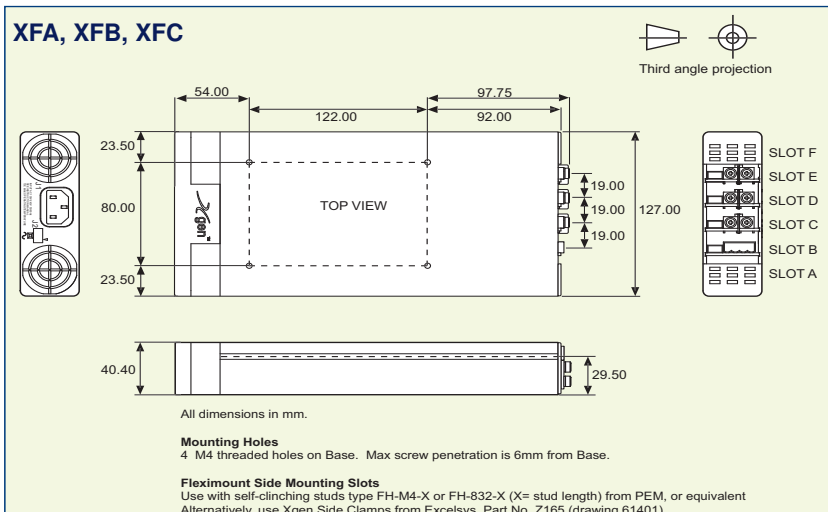

SPECIFICATION applies to configured units consisting of **powerMods** modules plugged into the appropriate **powerPac**

INPUT					
Parameter	Conditions/Description	Min	Nom	Max	Units
Input Voltage Range	Universal Input 47 - 63Hz. Input: 390 - 440Hz.	85		264	VAC
		90		120	VAC
Power Rating	XFA			400	W
	XFB			700	W
	XFC			1000	W
Input Current	XFA	85VAC in	400W out	7.5	A
	XFB	85VAC in	700W out	9.5	A
	XFC	85VAC in	765W out	11.5	A
Inrush Current	230VAC @ 25°C			25	A
Undervoltage Lockout	Shutdown	65		74	VAC
Fusing	XFA	250V		F8A HRC	
	XFB	250V		F10A HRC	
	XFC	250V		F12A HRC	
OUTPUT					
Parameter	Conditions/Description	Min	Nom	Max	Units
powerMod Power	As per powerMod table				
Output Adjustment Range	Manual or Electronic				
Minimum Load	As per powerMod Table		0		A
Line Regulation	For ±10% change from nominal line			±0.1	%
Load & Cross Regulation	For 25% to 75% load change			±0.2	%
Transient Response	For 25% to 75% load change	Voltage Deviation		10	%
		Settling Time		250	µs
Ripple and Noise	20MHz Bandwidth 100mv or 1.0% pk-pk				
Overvoltage Protection	Two-Level: 1st Level: Vset Tracking, 2nd Level: Vmax (Latching)	110	130	150	%
Overcurrent Protection	Straight line with hiccup activation at <30% of Vnom	110		120	%
Remote Sense	Max. line drop compensation. (except Xg7, Xg8)			0.5	VDC
Overshoot				2	%
Turn-on Delay	From AC In / Enable signal			600 / 30	ms
Rise Time	Monotonic			5	ms
Hold-up Time	For nominal output voltages at full load.	20			ms
Output Isolation	Output to Output / Output to Chassis	500 / 500			VDC
GENERAL					
Parameter	Conditions/Description	Min	Nom	Max	Units
Isolation Voltage	Primary to Secondary Input to Chassis	3000			VAC
		1500			VAC
Efficiency	230VAC, 1000W @ 24V		91		%
Safety Agency Approvals	EN60950, UL60950, CSA22.2 No.950 UL File No. E181875				
Earth Leakage Current	230VAC, 50Hz, 25°C			1.5	mA
Bias Supply	Always ON. Current 250mA	4.8	5.0	5.5	VDC
Reliability	Telcordia SR-332 at 25°C and full load			1020	kh
	Telcordia SR-332 at 25°C and full load			1057	kh
	MIL-STD-217F at 25°C and full load			86	kh
	MIL-STD-217F at 25°C and full load			77	kh
EMC					
Parameter	Standard	Level		Units	
Emissions					
Conducted (note 5)	EN55011, EN55022, FCC: Level B		Compliant		
Radiated (note 5)	EN55011, EN55022, FCC: Level B		Compliant		
Harmonic Distortion	EN61000-3-2 Class A & MIL-STD-1399 SECTION 300A		Compliant		
Flicker and Fluctuation	EN61000-3-3		Compliant		
Immunity					
Electrostatic Discharge	EN61000-4-2: Level 2		Compliant		
Radiated RFI	EN61000-4-4: Level 3 & MIL-STD-461F		Compliant		
Fast Transients - burst	EN61000-4-4: Level 3		Compliant		
Input Line Surges	EN61000-4-5: Level 3 & MIL-STD-1399		Compliant		
Conducted RFI	EN61000-4-6: Level 3 & MIL-STD-461F		Compliant		
Voltage Dips	EN61000-4-11 & MIL-STD-704		Compliant		
ENVIRONMENTAL					
Parameter	Conditions/Description	Min	Nom	Max	Units
Operating Temperature		-55		+70	°C
Storage Temperature		-55		+75	°C
Derating	Contact Excelsys for full temperature deratings				
Acoustic Noise			56.5		dBA
Relative Humidity	Non-condensing	5		95	%RH
Shock	3000 Bumps, 10G (16ms) half sine				
Vibration	1.5G : MIL-STD-810G	10		500	Hz

- NOTES**
1. This product is not intended for use as a stand alone unit and must be installed by qualified personnel.
 2. The specifications contained herein are believed to be correct at time of publication and are subject to change without notice.
 3. All specifications at nominal input, full load, 25°C unless otherwise stated.
 4. When powering inductive or capacitive loads, it is recommended to use a blocking diode on the output.
 5. Conformal Coated powerMods, Xg1C to Xg8C, MUST be used with XF powerpacs.
 6. An external filter is required to meet the conducted and radiated emissions requirements for MIL-STD-461F. For further details contact support@excelsys.com.



<p>Europe/Asia Excelsys Technologies Ltd 27 Eastgate Drive Eastgate Business Park Little Island, Cork, Ireland IRELAND</p>	<p>t: +353 21 4354716 f: +353 21 4354864 e: sales@excelsys.com</p>	<p>North America Excelsys Technologies 519 Interstate 30, #309 Rockwall, TX 75087 USA</p>	<p>t: (972) 771 4544 f: (972) 421 1805 e: salesusa@excelsys.com</p>
---	--	--	---

Voltage Adjustment - Local

The multi-turn potentiometer that adjusts each output within the specified range may be accessed via the output panel of the power supply. Clockwise rotation increases output voltage. Resolution is approximately 5% of nominal voltage (Vnom) per turn. Certain applications may require military grade potentiometer or fixed resistors - consult Excelsys for details.

Voltage Adjustment - Remote (resistive / electronic)

The output voltage may be adjusted or trimmed by means of an external resistor or potentiometer network connected to the Vtrim pin. Linear Electronic programming is also possible and may be implemented according to the formula $V_{out} = K V_{control}$.

Parallel Connection

To achieve increased current capacity, simply parallel outputs using the standard parallel links. Excelsys 'wireless' sharing ensures that current hogging is not possible. To parallel connect outputs:

1. Switch on IShare switch to ON on powerMods.
2. Connect Negative parallel link.
3. Adjust output voltages of powerMods to within 5mV of each other.
4. Connect Positive Parallel Link.

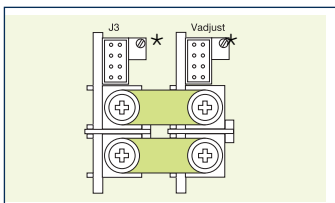

Parallel Links available to order. Part Number XP1

*Certain applications may require military grade potentiometer or fixed resistors - consult Excelsys for details.

Series Connection

To achieve increased output voltages, simply series outputs using standard series links, paying attention to the requirements to maintain SELV levels if required in your system.

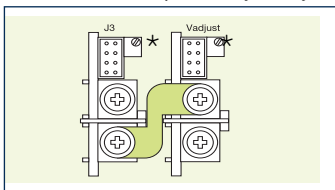

Series Links available to order. Part Number XS1

*Certain applications may require military grade potentiometer or fixed resistors - consult Excelsys for details.

Remote Sensing

When the load is remote from the power supply, the remote sense pins may be used to compensate for dynamic impedance effects caused by the power cabling.

Bias Voltage

A SELV isolated 5V (always on) bias voltage rated at 250mA is provided on J2 to facilitate miscellaneous system control functions.

Current Limit Adjustment

The output current limit setting may be adjusted (downwards only) by means of an external resistor connection to the I trim pin.

Inhibit/Enable

Inhibiting may be implemented either globally or on a per module basis (*powerPac* or *powerMod* inhibiting). Reverse logic (Enabling) may also be implemented.

AC Fail

Open collector signal indicating that the input voltage has failed or is less than 80Vac. This signal changes state giving 5ms of warning before loss of output regulation.

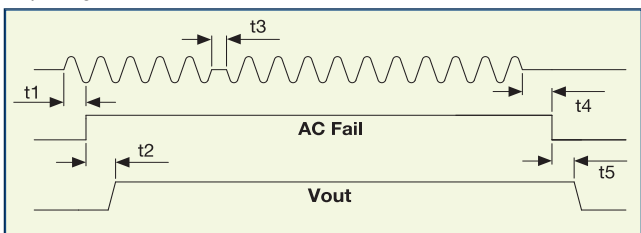

Temperature Alarm (Option 01)

Open collector signal indicating excessive *powerPac* temperatures due to fan failure or operation beyond ratings. This signal is activated at least 10ms prior to system shutdown.

Fan Fail (Option 01)

Open collector signal indicating that at least one of the system fans have failed. This does not cause system shutdown.

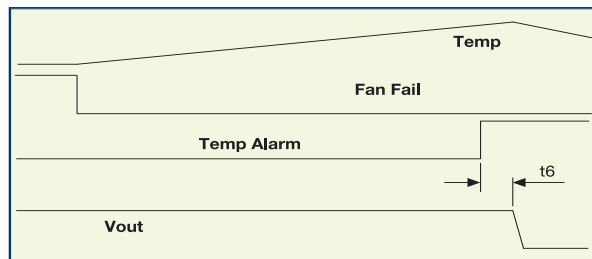

Power Good

Opto-isolated output signal indicates that the *powerMod* is operating correctly and output voltage is within normal band. Opto transistor ON = Good.

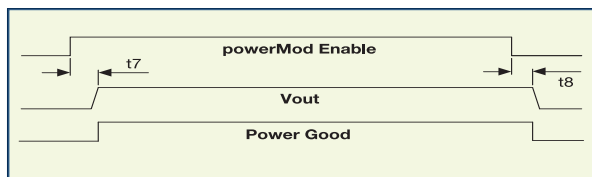

Indication LED's

Each *powerMod* has a visual indicator to identify that it is operating within normal ratings. Very useful for system diagnosis.

Signal Connector Pinout

Pin	J2 (<i>powerPac</i>)	J3 (<i>powerMod</i>) Type A	J3 (<i>powerMod</i>) Type B
1	common	+sense	+pg (V2)
2	+5V bias	-sense	-pg (V2)
3		V trim	inhibit (V2)
4	ac fail	I trim	common (V2)
5	fan fail	+inhibit/enable	+pg (V1)
6	global enable	-inhibit/enable	-pg (V1)
7	temp alarm	+power good	inhibit (V1)
8	global inhibit	-power good	common (V1)

Signal Connector Pinout

TYPE A Xg1-Xg7

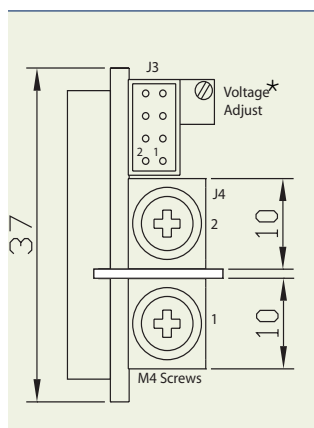

J4 Connector : M4 Screw
J3 Connector Mating Connector
Housing: Locking Molex 51110-0860
Non Locking Molex 51110-0850
Crimp Terminal: Molex p/n 50394

*Certain applications may require military grade potentiometer or fixed resistors - consult Excelsys for details.

TYPE B : Xg8

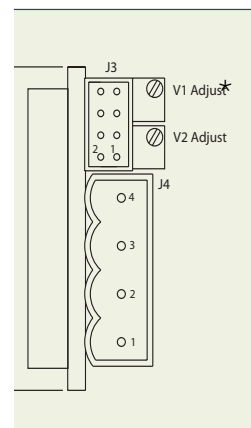

J4 Connector : Camden 9200/4A
J3 Connector Mating Connector
Housing: Locking Molex 51110-0860
Non Locking Molex 51110-0850
Crimp Terminal: Molex p/n 50394

*Certain applications may require military grade potentiometer or fixed resistors - consult Excelsys for details.

XF Series Derating Curves

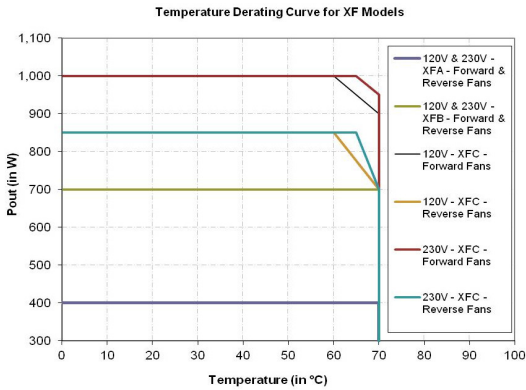

XF Series Derating Curves

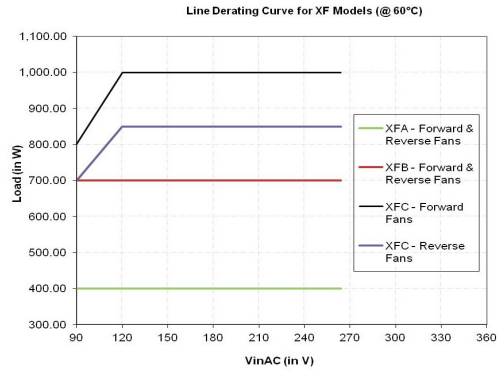

Hi-Rel COTS

powerMods (for use with all powerPac models)

MODEL	Vmin Vtrim	Vnom Vpot *	Vmax	Imax	Watts	
Xg1C	1.0	1.5	2.5	3.6	50A	125W
Xg2C	1.5	3.2	5.0	6.0	40A	200W
Xg3C	4.0	6.0	12.0	15.0	20A	240W
Xg4C	8.0	12.0	24.0	28.0	10A	240W
Xg5C	8.0	24.0	48.0	53.0	6A	288W
Xg7C	5.0	5.0	24.0	28.0	5A	120W
Xg8Cv1	5.0	5.0	24.0	28.0	2.5A	60W
v2	5.0	5.0	24.0	28.0	2.5A	60W

*Certain applications may require military grade potentiometer or fixed resistors - consult Excelsys for details.

powerPacs (6slot package, 127mm wide)

MODEL	Watts
XFA	400W
XFB	700W
XFC	1000W

Conformal Coated powerMods, Xg1C to Xg8C, MUST be used with XF powerpacs

Part Numbering

Configured Units may be specified and ordered using the part numbering system shown opposite. For example, part number XFC123420S01 specifies the following 1000W power supply.

- XFCS01 powerPac 1000W powerPac
- Xg1C 2.5V @ 50A powerMod
- Xg2C 5V @ 40A powerMod
- Xg3C 12V @ 20A powerMod
- Xg4C 24V @ 10A powerMod
- Xg2C 5V @ 40A powerMod

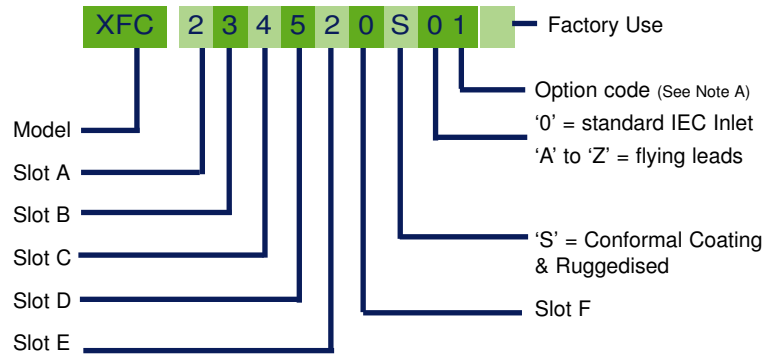

Note A: Option Codes
 1= Standard Model (with Thermal Signals)
 3= Reverse Fan
 5= Low Leakage Current
 7= Low Leakage Current & Reverse Fan

Accessories

PowerMods can be parallel connected for higher current and series connected for higher voltages. Configured units will have parallel and series links fitted as required.

Powerpac Connector Options

The default AC input connector is IEC however Xgen can also be supplied with a 3-wire input cable.

